



**CD** Series

Coffee distributor/tamper

Stability & fashion



Non-slip design

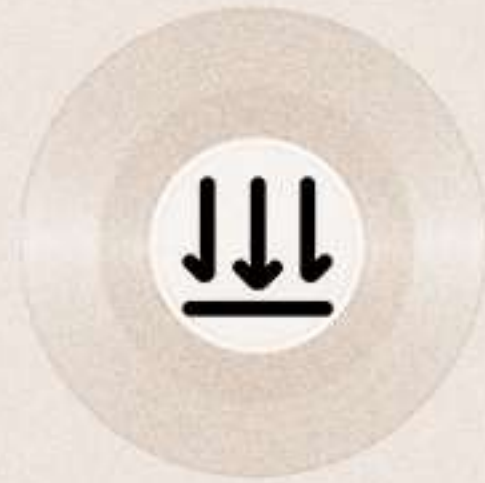

A textured tamping

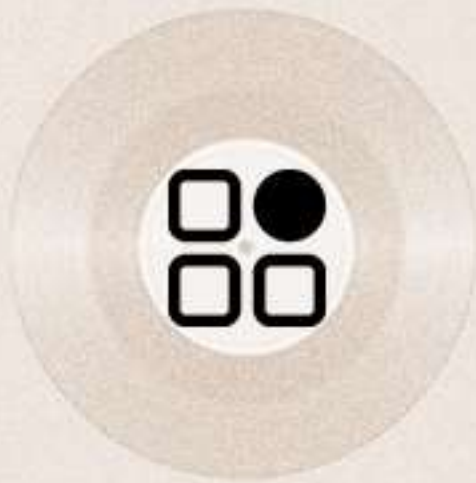

Multiple sizes



Selection material

## Rotating Tamping

Exquisite production process

The collision of solid wood and metal

The sparks of the collision of solid wood and metal  
dance to the melody of coffee

CD Series - Gripping

Show every coffee "powder"

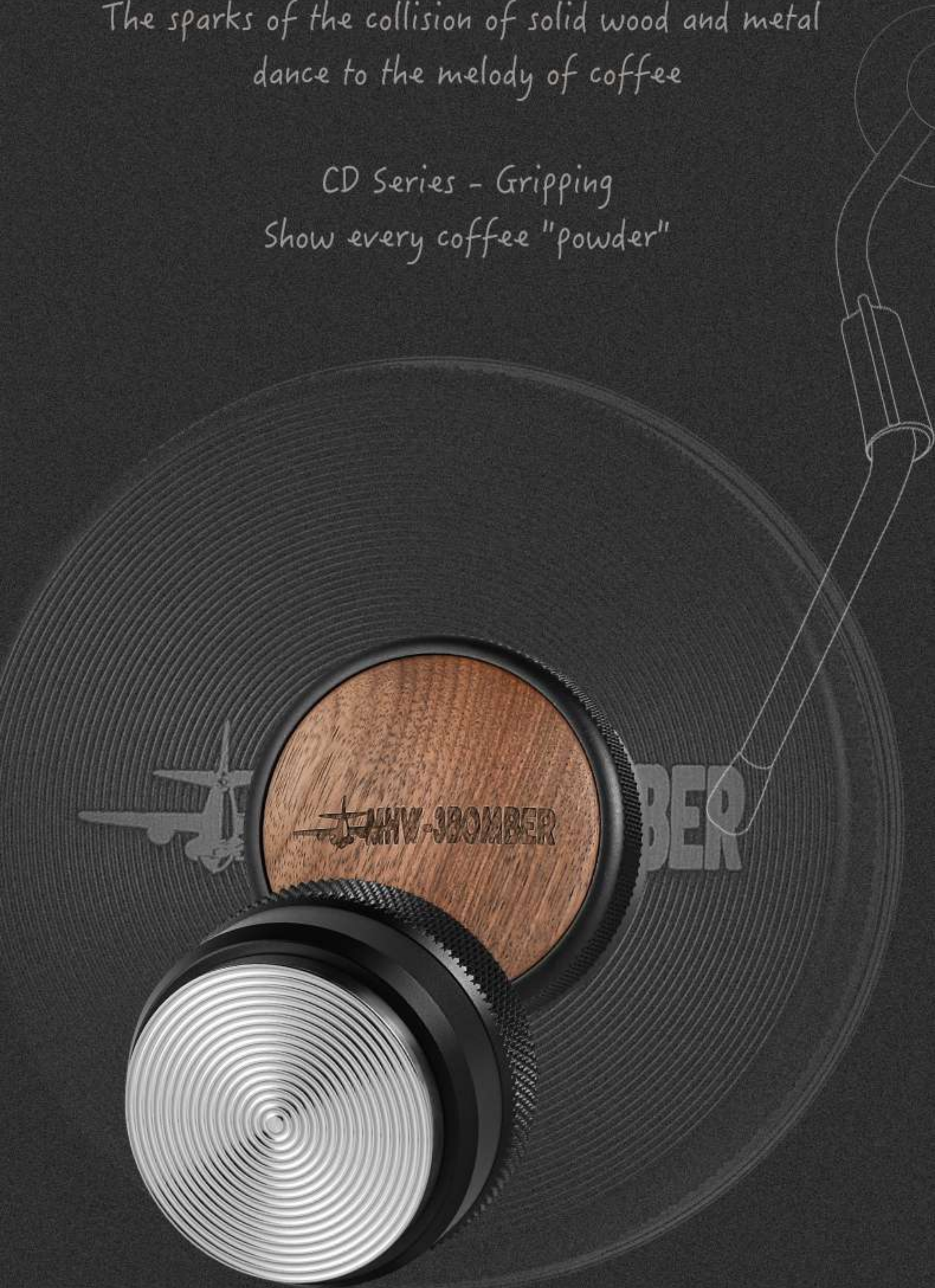

## TO GET AN ESPRESSO

Dynamic composition plays an important role

Makes coffee grounds flat, uniform and firm

Have a better extraction environment

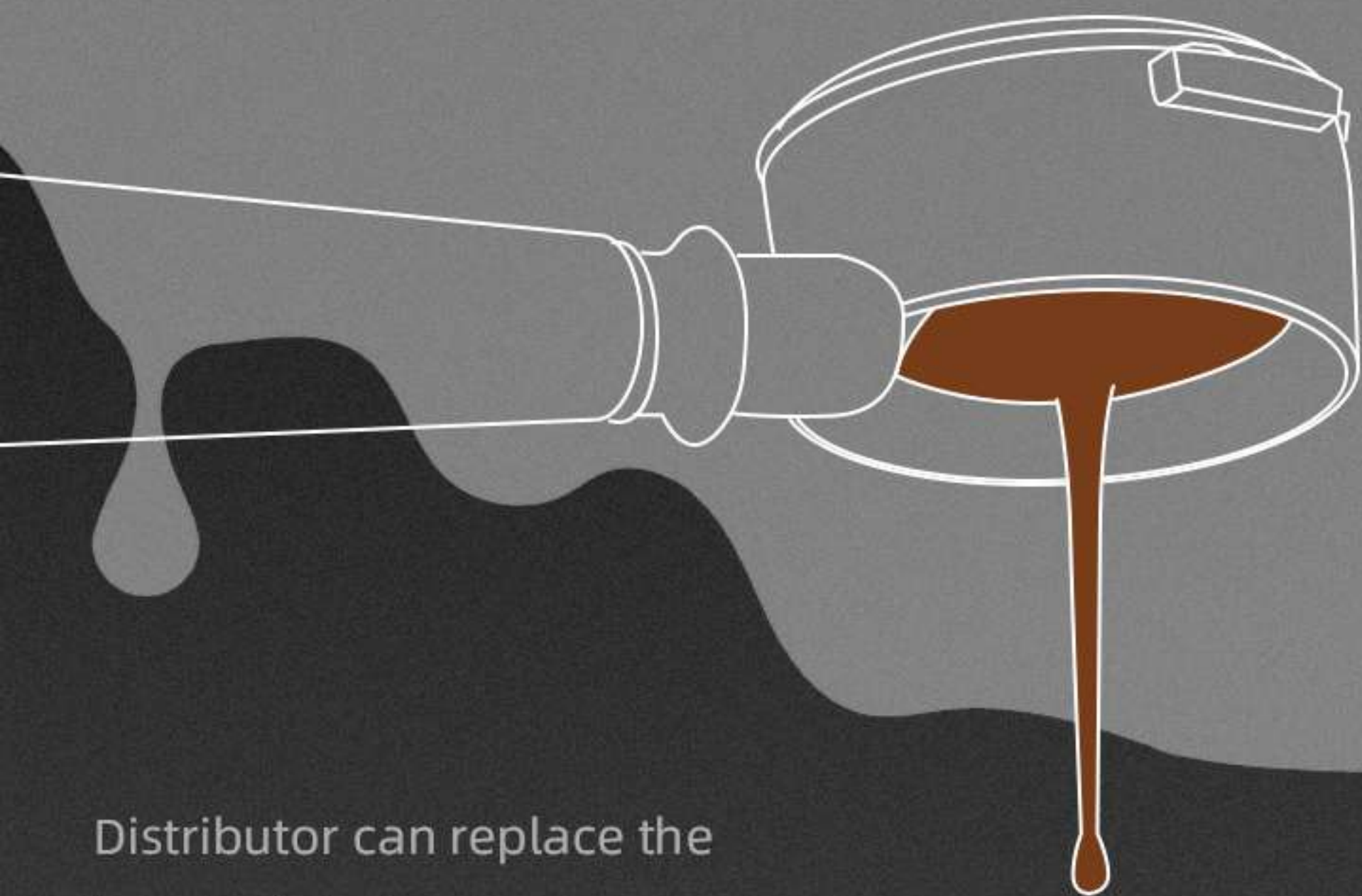
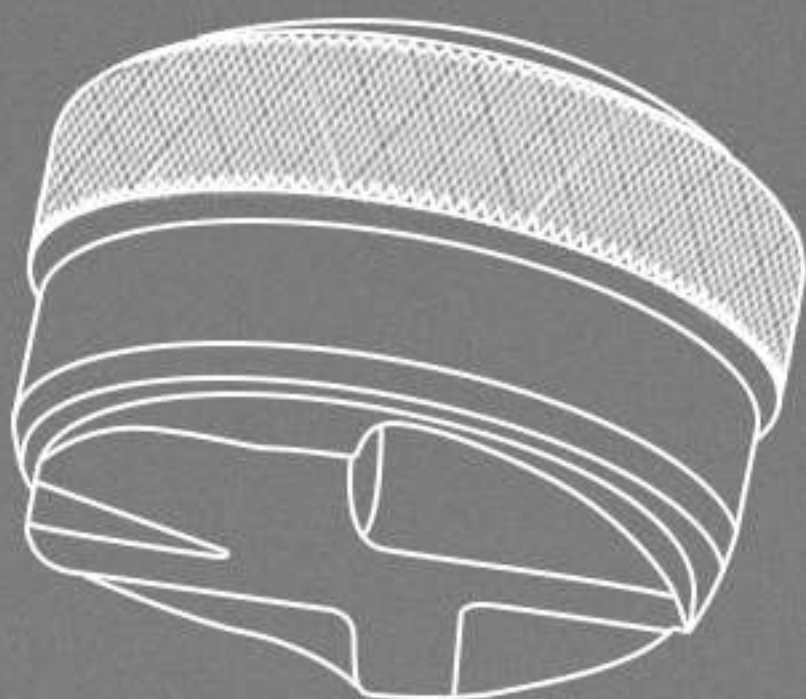

Distributor can replace the hand of The barista to touch the coffee grounds

Relatively effective in reducing channel effects

Can greatly improve the stability

Of extraction and concentration

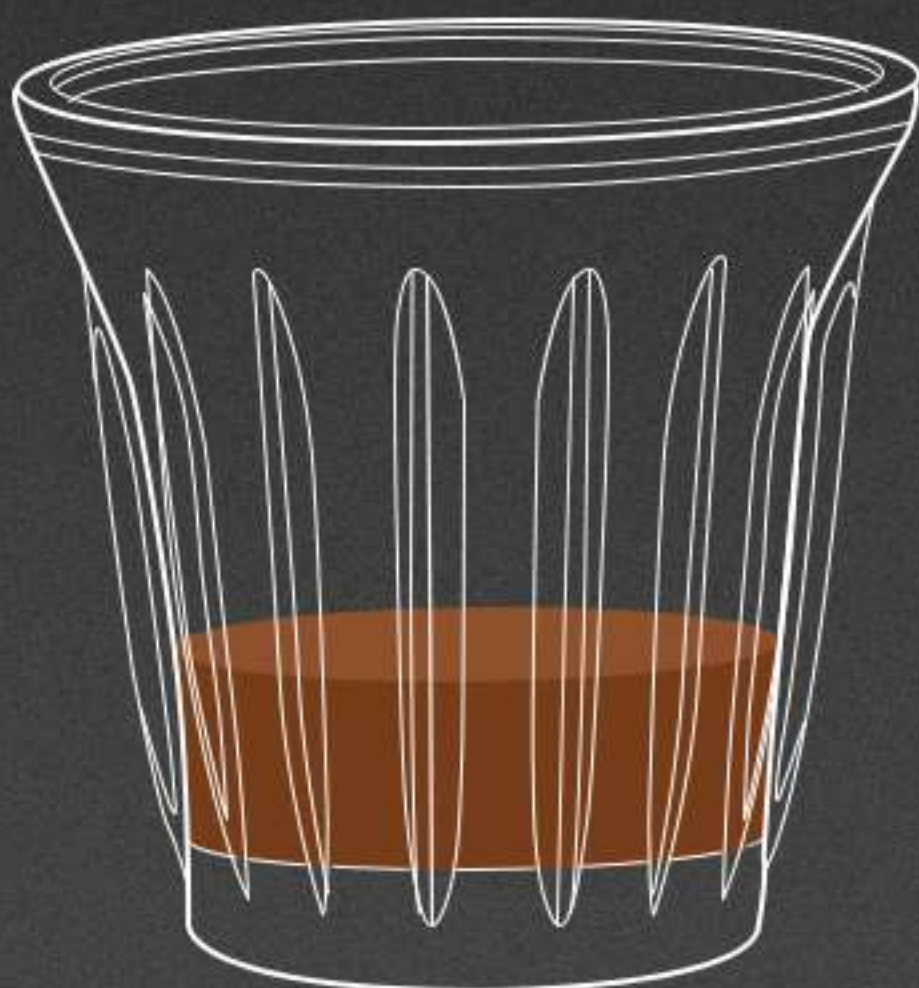

Collocation



## Distributor/Tamper

It works better when used together

Distributor - Distribute the powder evenly

Tamper- Vertical Tamping Smooth and compact



Distributor

Tamper

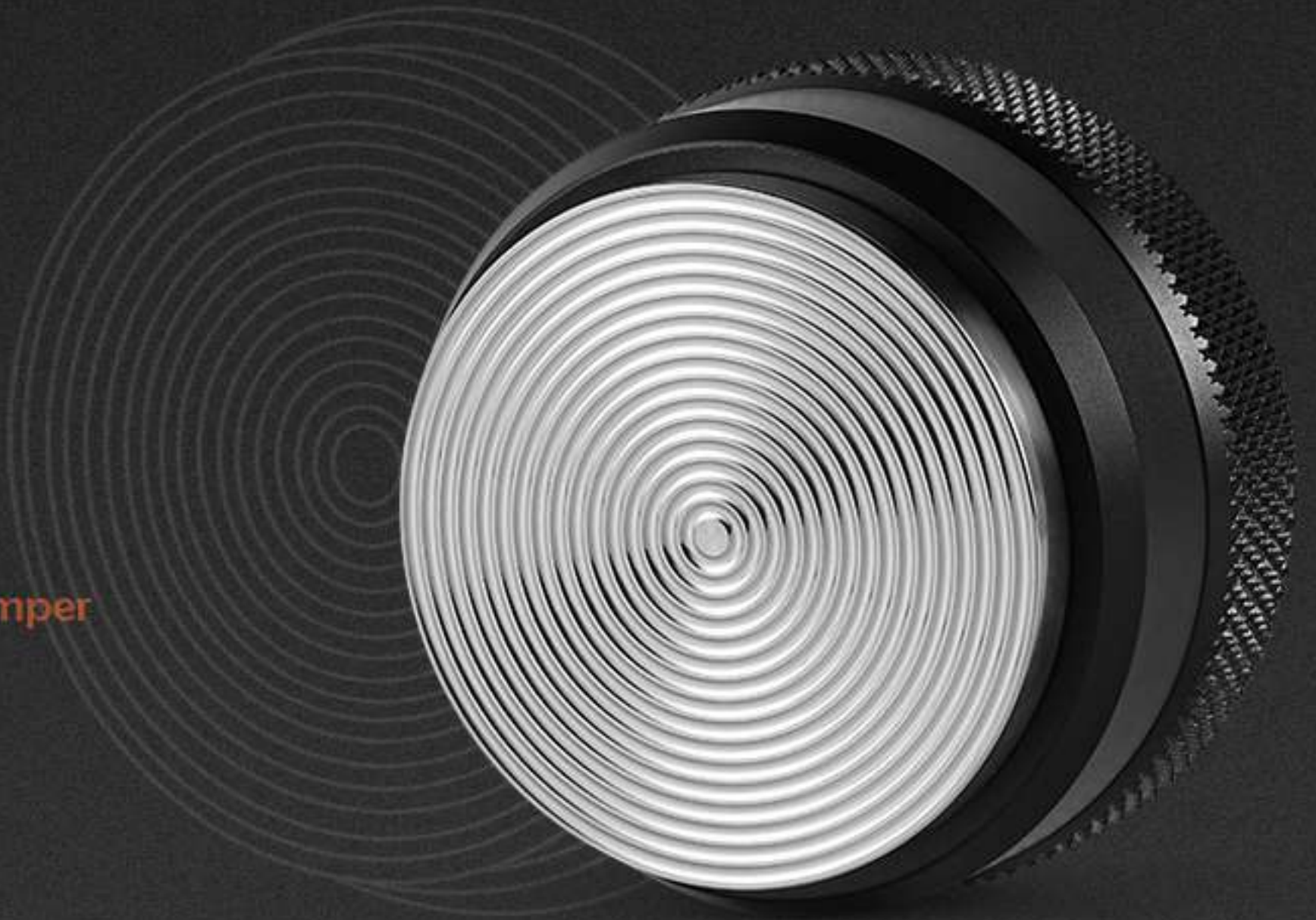

## USING THE DISTRIBUTOR/TAMPER EFFECT



Distributing Before



Distributing After



Tamping After

### ABOUT DIAMETER

The diameter of a basket labeled 58mm by a coffee maker in the market is at least 58.6mm,

And after repeated testing, Choosing a distributor and tamper with a diameter of 58.35mm can make the distributing and tamping more fit and effectively reduce residual powder.

### ABOUT THE HEIGHT ADJUSTMENT OF DISTRIBUTOR

According to the amount of powder to adjust the height of the distributor, it's just enough when surface flatted.

Adjust



# Rotate to adjust height Adjust according to your needs

Adjust according to the amount of powder  
Make the tamping pressure reasonable



Counterclockwise adjustment



Clockwise adjustment



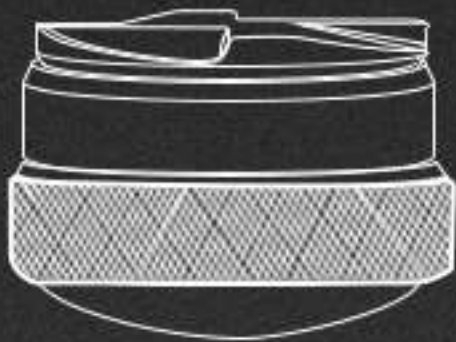

When adjusting the height  
please hold the upper lid tightly

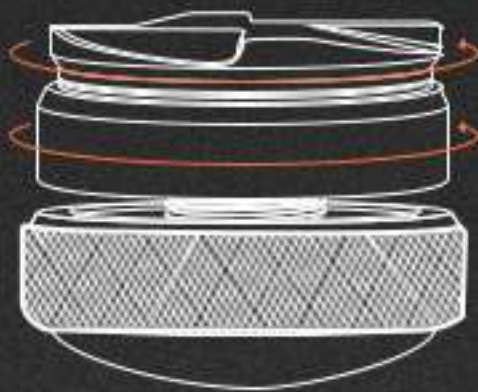

first rotate the adjusting ring  
and the base counterclockwise  
then rotate the  
base counterclockwise

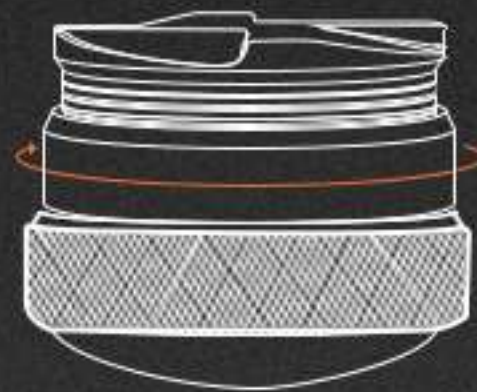

Finally rotate the  
adjusting ring clockwise  
to tighten the adjusting  
ring and the upper lid



Use



# A textured tamping Exquisite usage experience

Fit tightly into the basket  
Vertical tamping



Anti skidding 



**Knurling process crisscross  
effective anti-slip**

sturdy and durable  
refined aesthetic shape



Construction



Segmented design

Easy to assemble and use

Free disassembly

Easy to clean

Aluminum cover

Natural wood cover

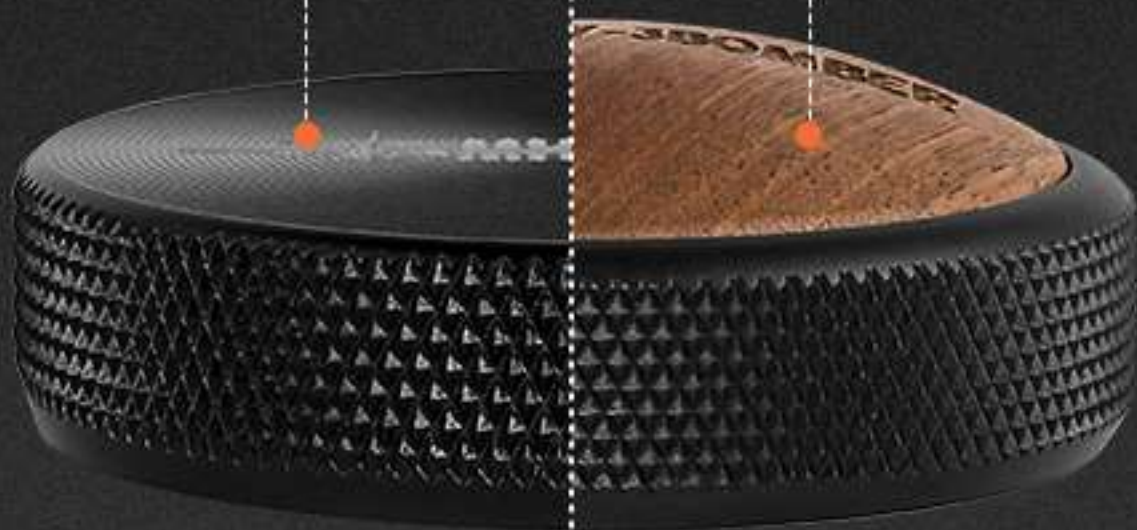

Aluminum alloy adjust ring



SUS 304 base



Adjust 



CP

three sizes

Commercial or household At your choice

Meet different application scenarios  
Switch freely



58.35mm



53mm



51mm

Logo

Brand logo

Quality Assurance



# NATIONAL STANDARD FOOD EXPOSURE TEST REPORT



APPROVED AFTER TESTING



项目	单位	指标	结果
感官测试	/	接触食品的表面应清洁，镀层不应开裂、剥落，焊接部分应光洁，无气孔、裂缝、毛刺	接触食品的表面清洁，无镀层，无焊接
		迁移试验所得浸泡液不应有异臭	迁移试验所得浸泡液无异臭
砷(As)	mg/kg	≤0.04	<0.03
镉(Cd)	mg/kg	≤0.02	<0.003
铅(Pb)	mg/kg	≤0.05	<0.03
铬(Cr)	mg/kg	≤2.0	0.22
镍(Ni)	mg/kg	≤0.5	<0.006

# INFORMATION

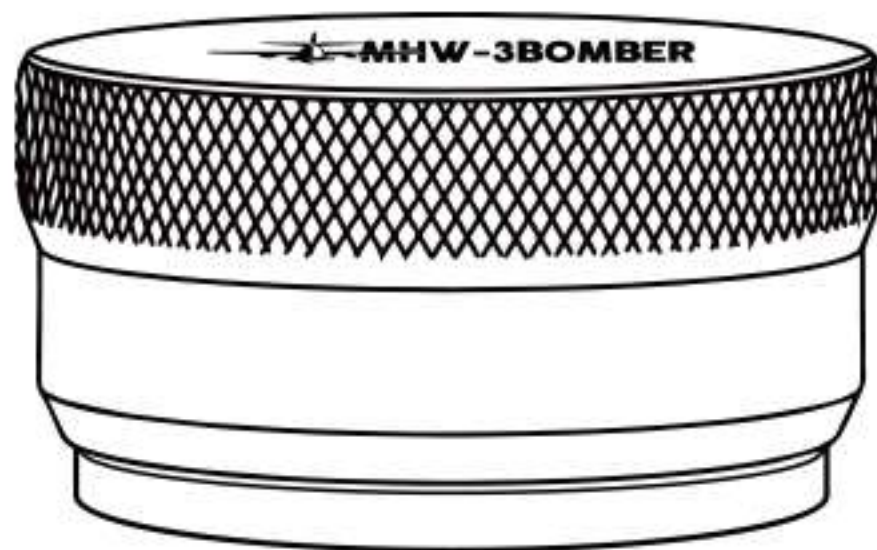

35mm

51mm

53mm

58.35mm



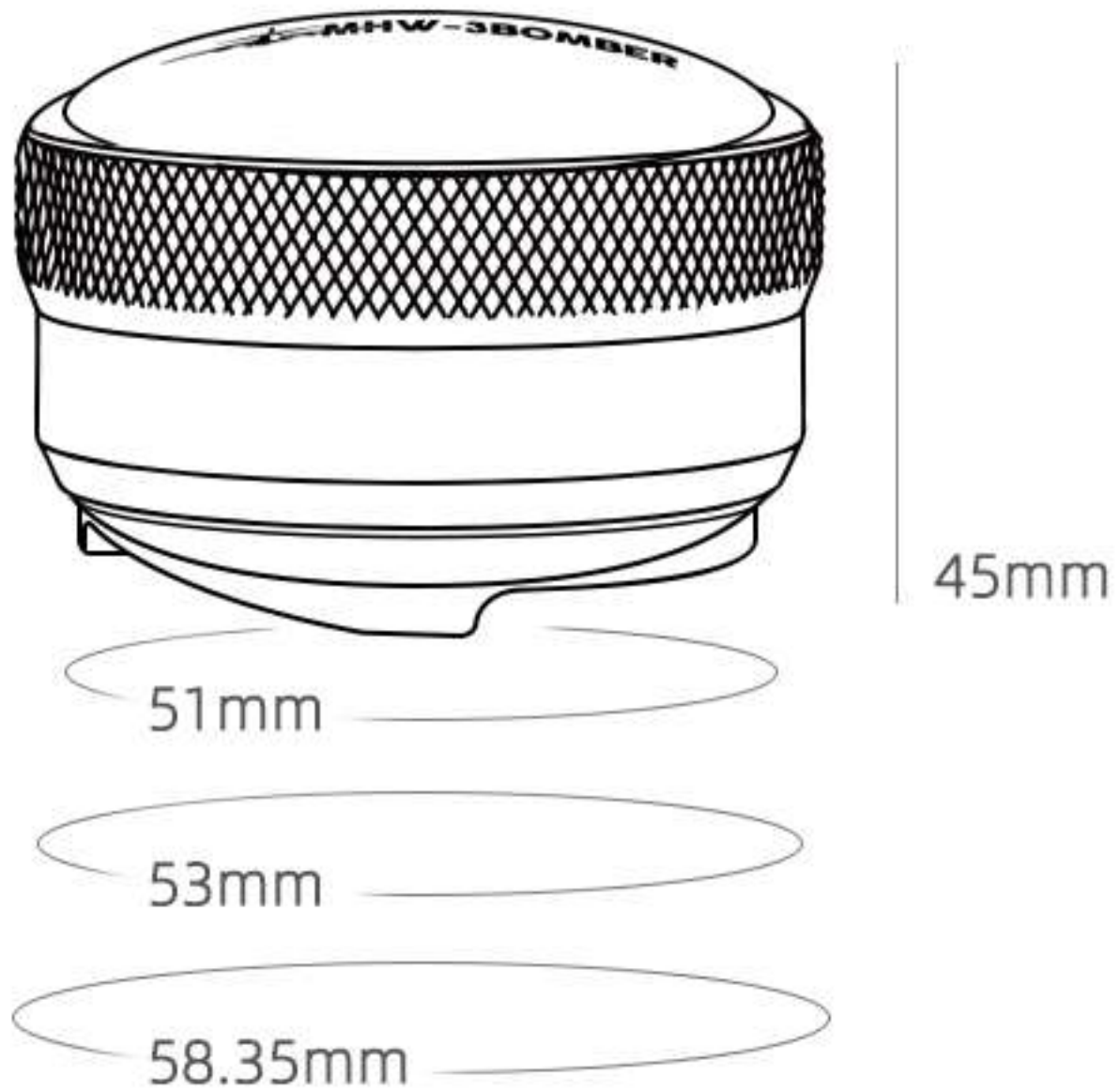

Purely manual measurement allows for errors, please prevail in kind.

<p>Brand</p> <p>MHW-3BOMBER</p>	<p>Name</p> <p>CD Series</p>
<p>Material</p> <p>SUS304、Walnut Aluminum</p>	<p>Specification</p> <p>51mm/53mm/58.35mm</p>
<p>Weight</p> <p>CD Wood Lid Edition: 425g/465g/505g</p> <p>CD Series: 415g/450g/485g</p>	<p>Origin</p> <p>China</p>

# WARM PROMPT



WARM PROMPT

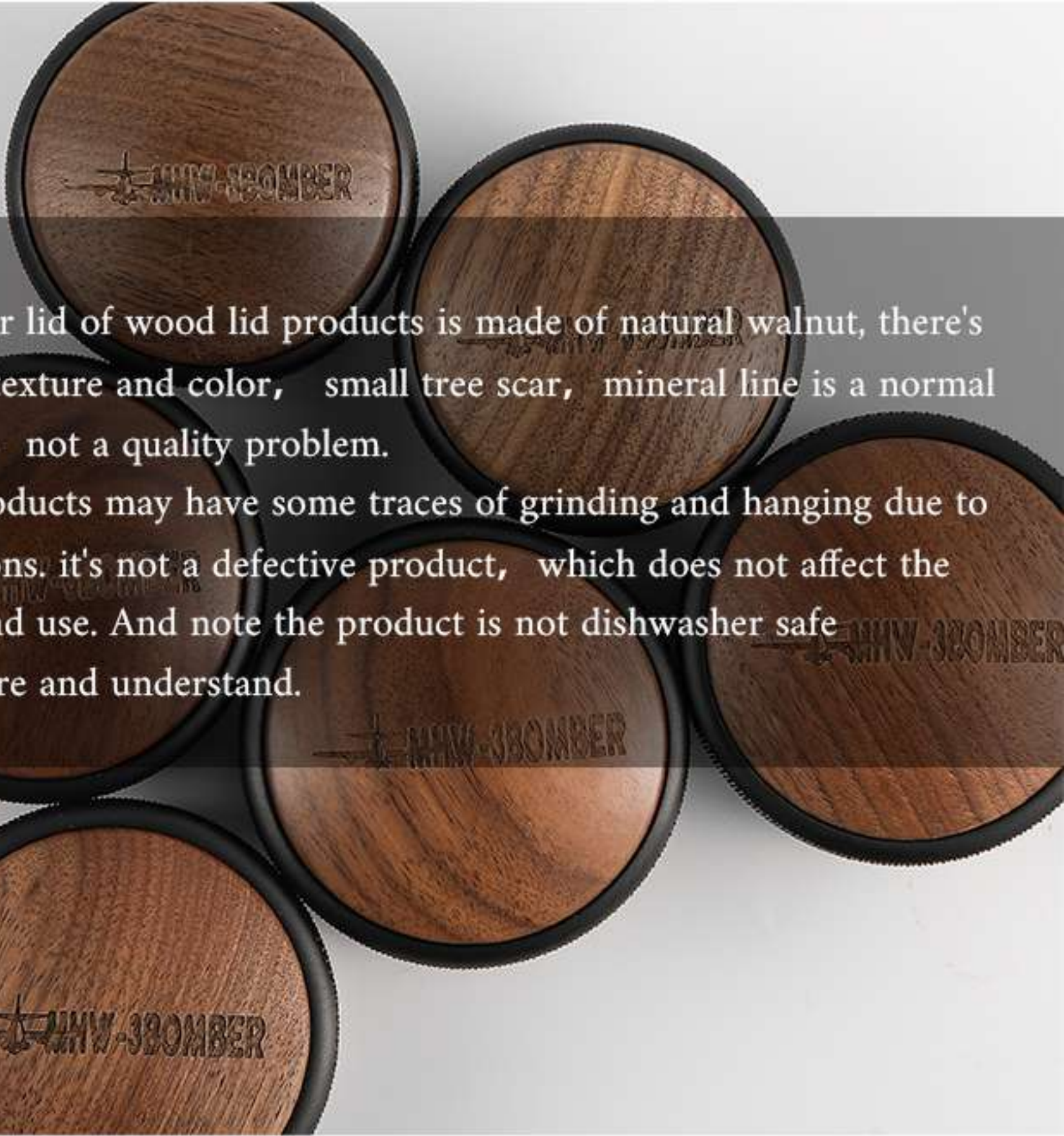

The upper lid of wood lid products is made of natural walnut, there's difference of texture and color, small tree scar, mineral line is a normal phenomenon, not a quality problem.

Metal products may have some traces of grinding and hanging due to material reasons. it's not a defective product, which does not affect the appearance and use. And note the product is not dishwasher safe please be aware and understand.