



# ***Race M1***

***Innovative design***

***Start your new  
experience***



# Upgraded accuracy

## Give you new grinding experience



Six star  
stainless steel burr



Point to  
point adjustment



Return to  
zero design



Free to  
disassemble



# Six star CNC420 stainless steel burr Evenly grinding and better flavour

Use six-star stainless steel burr, stronger and harder, 38mm diameter, sharp and efficient, Reduce fine powder rate, remain tasty coffee flavour.



# Why we choose six star stainless steel burr?

Brings better flavour than traditional burr

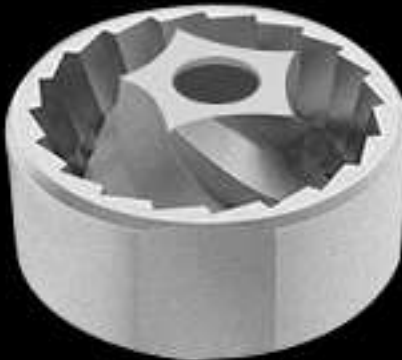
		
Mode	Race M1	Traditional
Burr	Six-star	Five-star
Size	Φ38mm	Φ38mm
Material	SUS420	SUS304
Uniformity	★★★★★	★★★★☆
Flavour	Clear and well arranged	Balanced

***Details make the performance better***

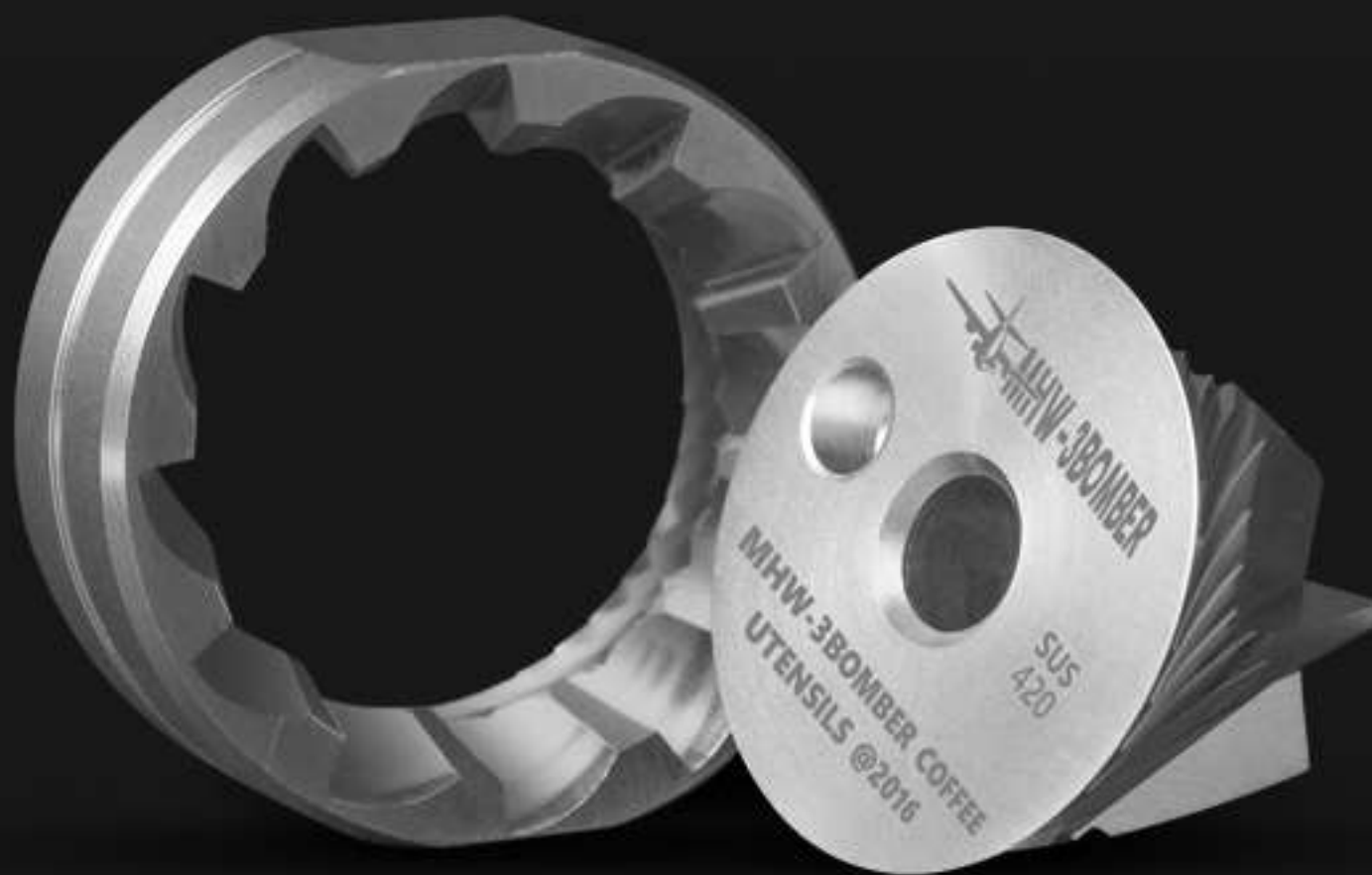

# SCA Cupping Standard

## Measurement of powder diameter distribution

The powder diameter of Race M1 shows a high concentration  
Uniformity increased and fine powder rate reduced

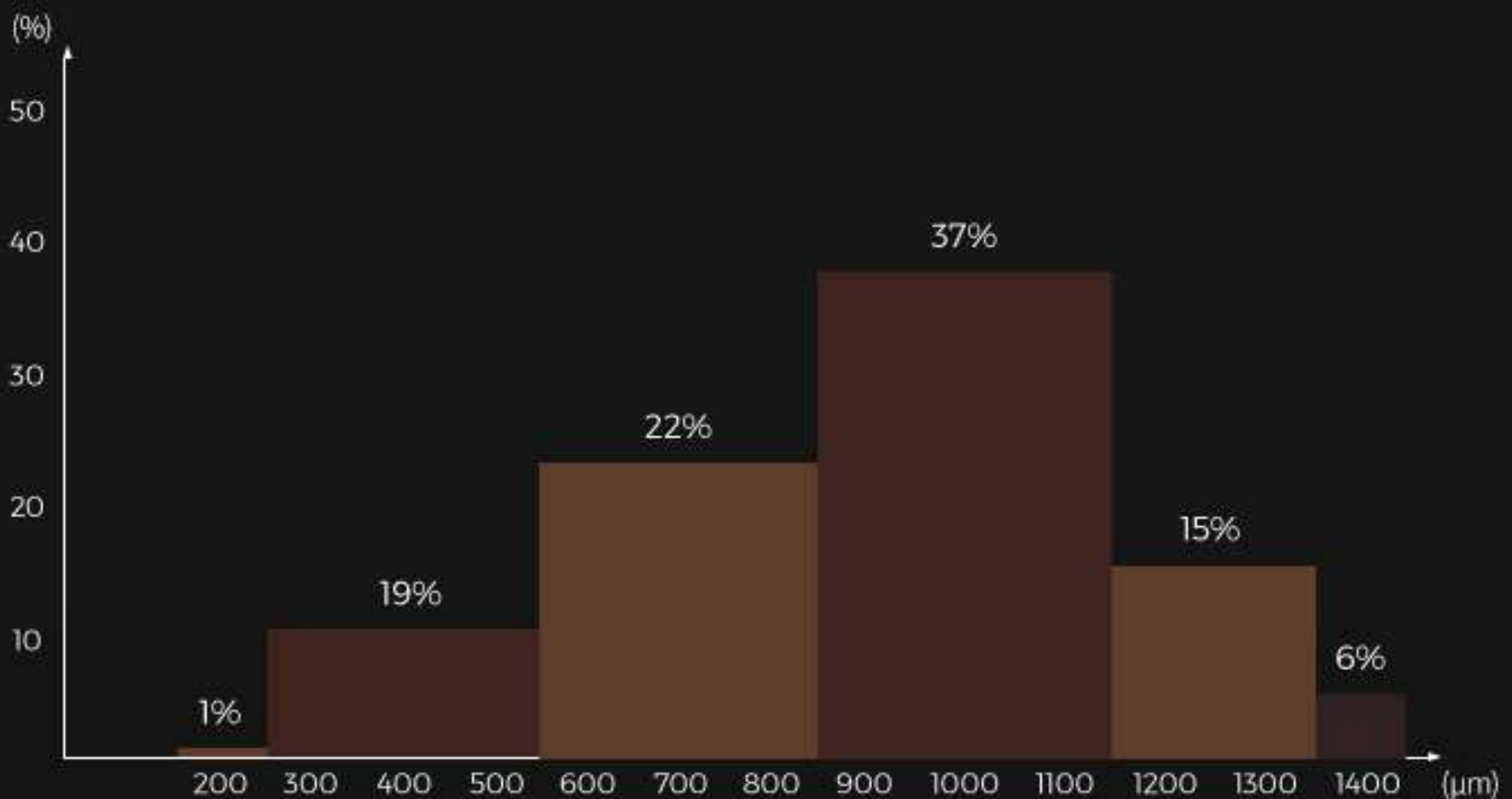

\*Cupping data, SCA standard 20# (Aperture 850μm) test

# Point to point adjustment

24 numbers of coarseness adjustment, let users adjust the coarseness more precisely Meet different needs like espresso, moka, drip coffee or french press



Race M1 Manual Grinder  
3BOMBER

Race M1  
Manual Grinder

Race M1  
Manual Grinds

0 1 2 3 4 5 6 7 8 9 10 11 12 13 14 15 16 17 18 19 20 21 22 23

# 0.04mm accuracy, meet wide needs

## Clear marks, easy to use

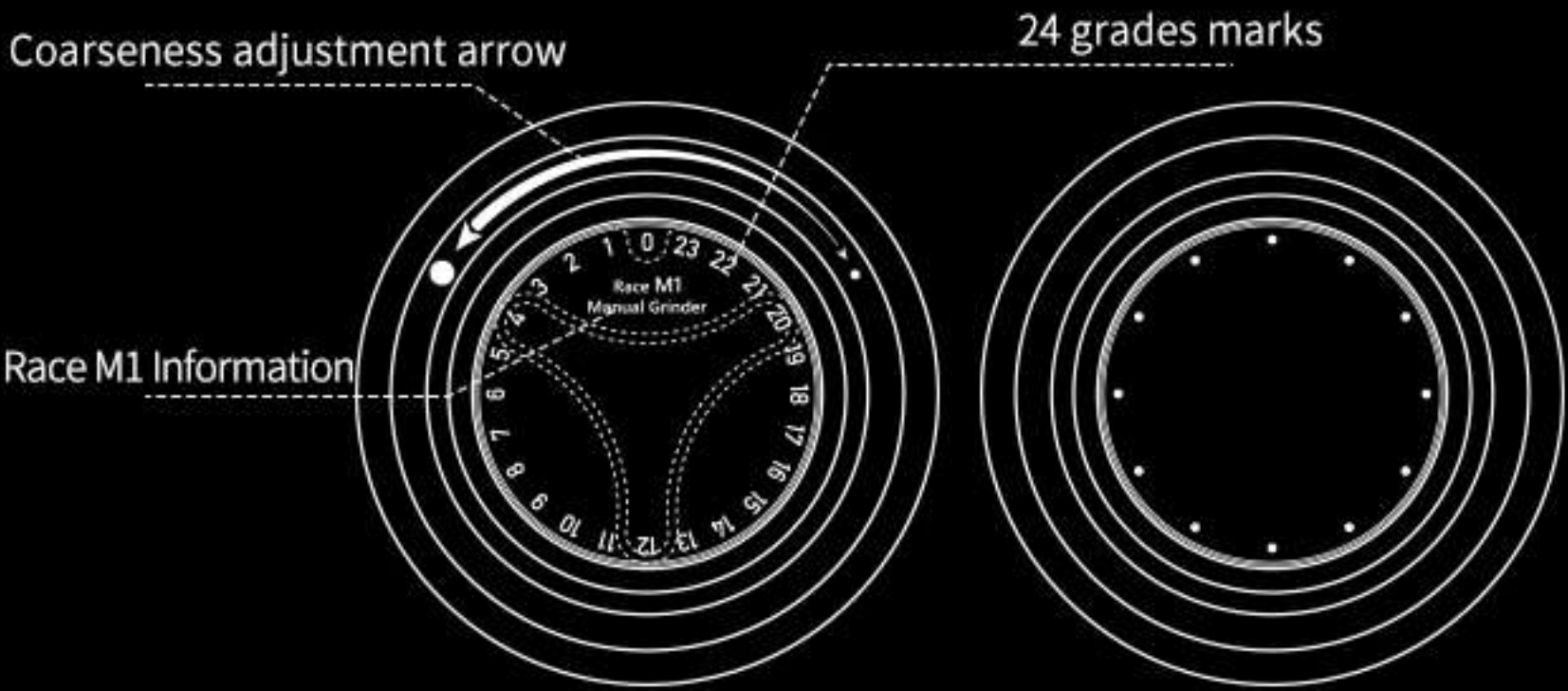

Mode	Race M1 Grinder	Traditional Grinder
Number Marks	Laser mark	no number
One Circle	24 grids	12 grids
Accuracy	0.04mm/grade	0.08mm/grade
Use	More convenient and accurate	complicate and error-pone

## Return to "0" design

Traditional manual grinder's scale cannot return to 0.  
 Race M1 break down the technological barriers and solve this problem





# Clockwise-fine Anticlockwise-Coarse



## Grinding recommendation



细

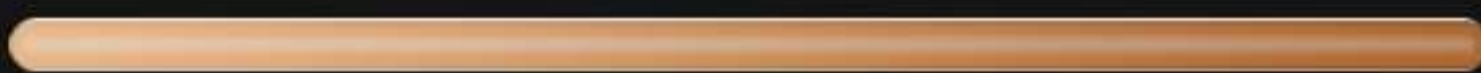

粗



ESPRESSO

19-22 GRIDS



MOKA

22-25 GRIDS



DRIP COFFEE

35-40 GRIDS



FRENCH PRESS

40-45 GRIDS

**Accurate structure**  
**Free to disassemble**

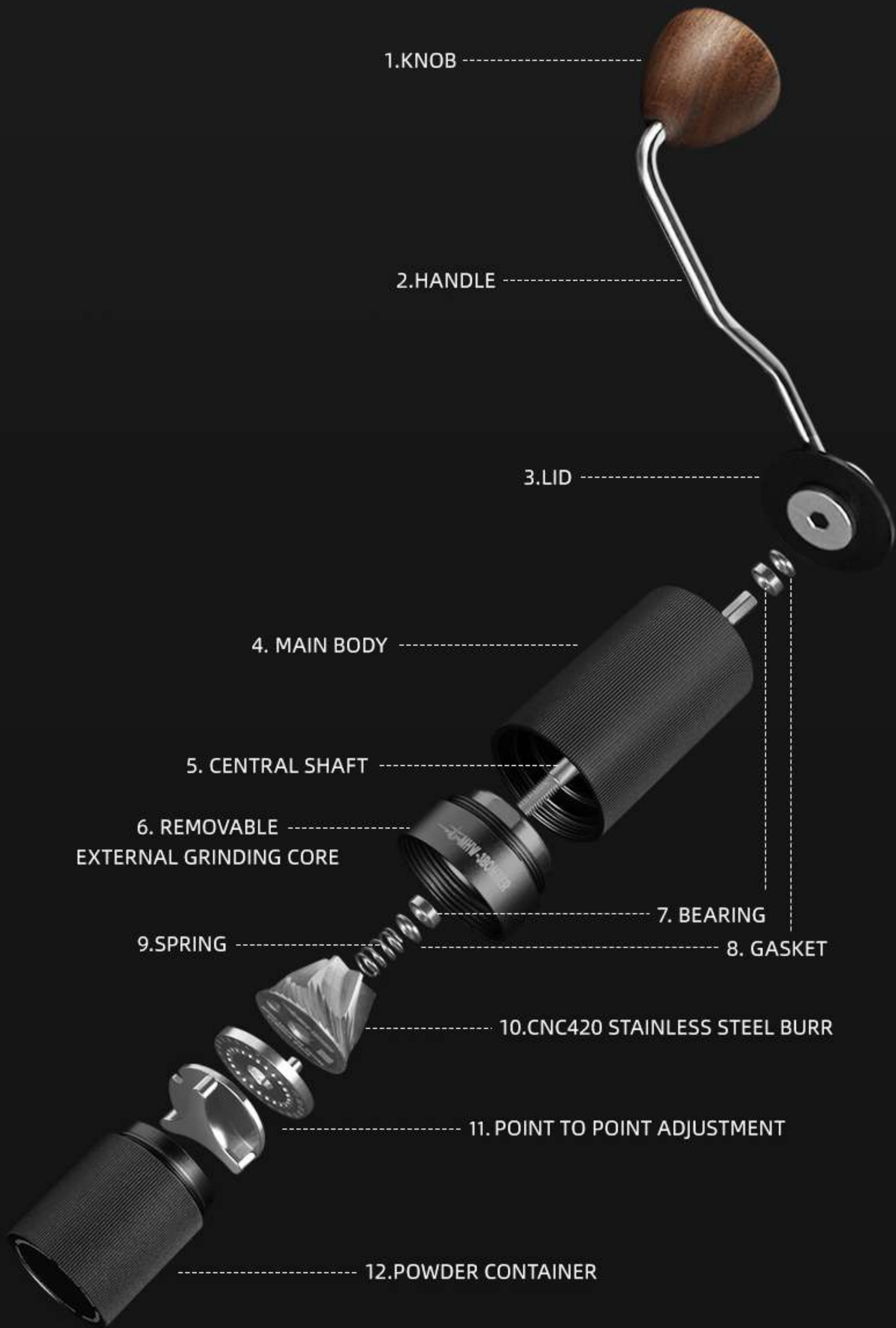

1.KNOB

2.HANDLE

3.LID

4. MAIN BODY

5. CENTRAL SHAFT

6. REMOVABLE  
EXTERNAL GRINDING CORE

7. BEARING

9.SPRING

8. GASKET

10.CNC420 STAINLESS STEEL BURR

11. POINT TO POINT ADJUSTMENT

12.POWDER CONTAINER

# Upgraded structure, allows deep cleaning

In daily use, if the grinder is not cleaned regularly, the residual old powder will pollute the newly ground coffee powder, resulting in flavor destruction. In order to deal with this problem, Racing M1 adopts a three-stage detachable structure to make cleaning a simple and comfortable process.



Race M1

Traditional

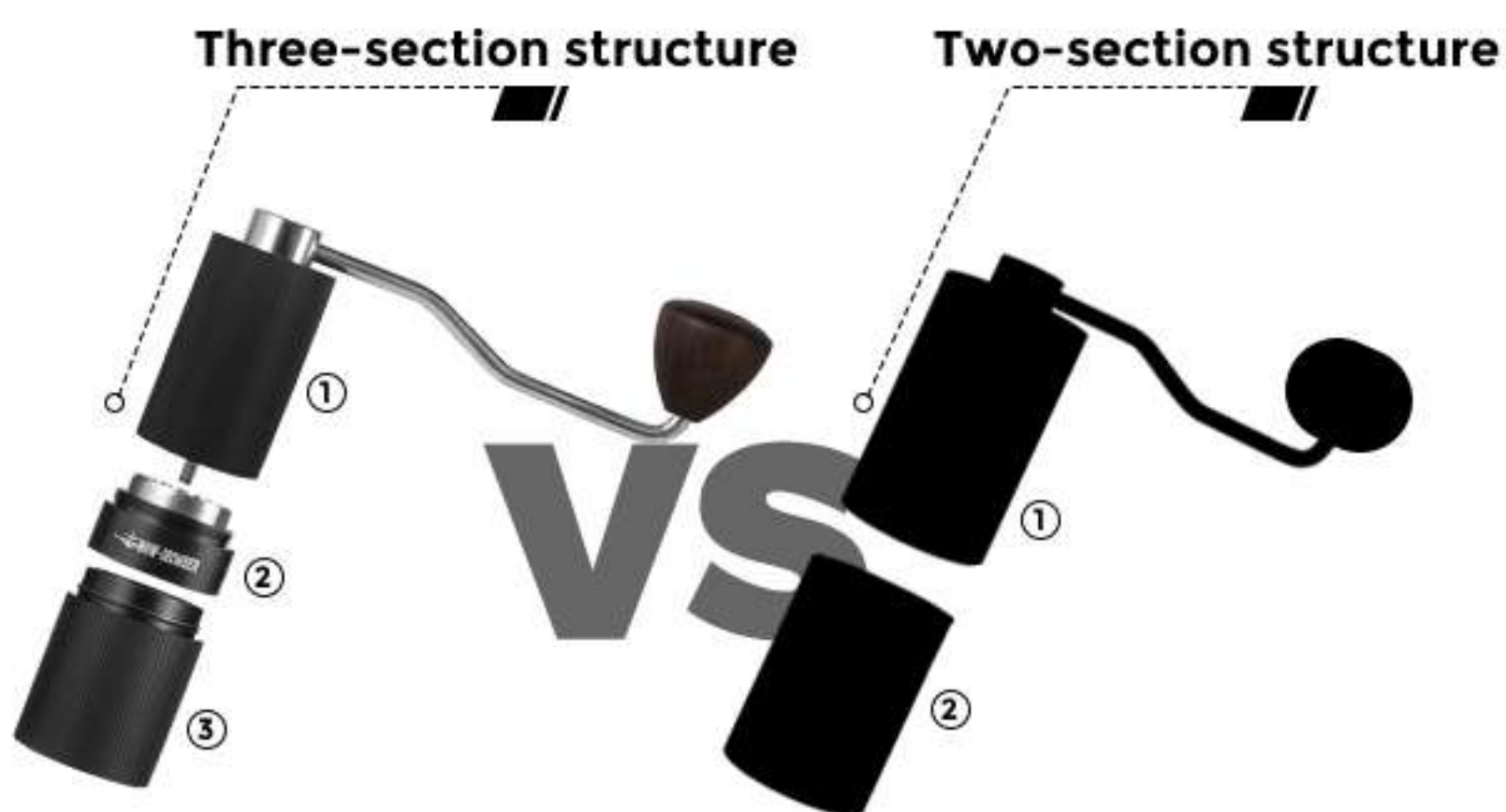

Traditional manual grinder often use two-section structure, resulting difficulty on thoroughly cleaning  
Race M1's burr was designed in seperately part, so as to clean it easily

\* This machine is equipped with precision parts. Please do not wash, clean with towel or cleaning brush;  
The edge of the core is sharp, please pay attention to avoid scratches.

# Wood matches different colors



AHW-3BOMBER

BLACK/WALNUT HANDLE





GREY/WALNUT HANDLE



SILVER/MAPLE HANDLE

# Focus on every details

## Aluminum alloy body

Quality and comfortable grip



## Ergonomic handle

Efficient and smooth



## Double-bearings structure

Stable and smooth grinding

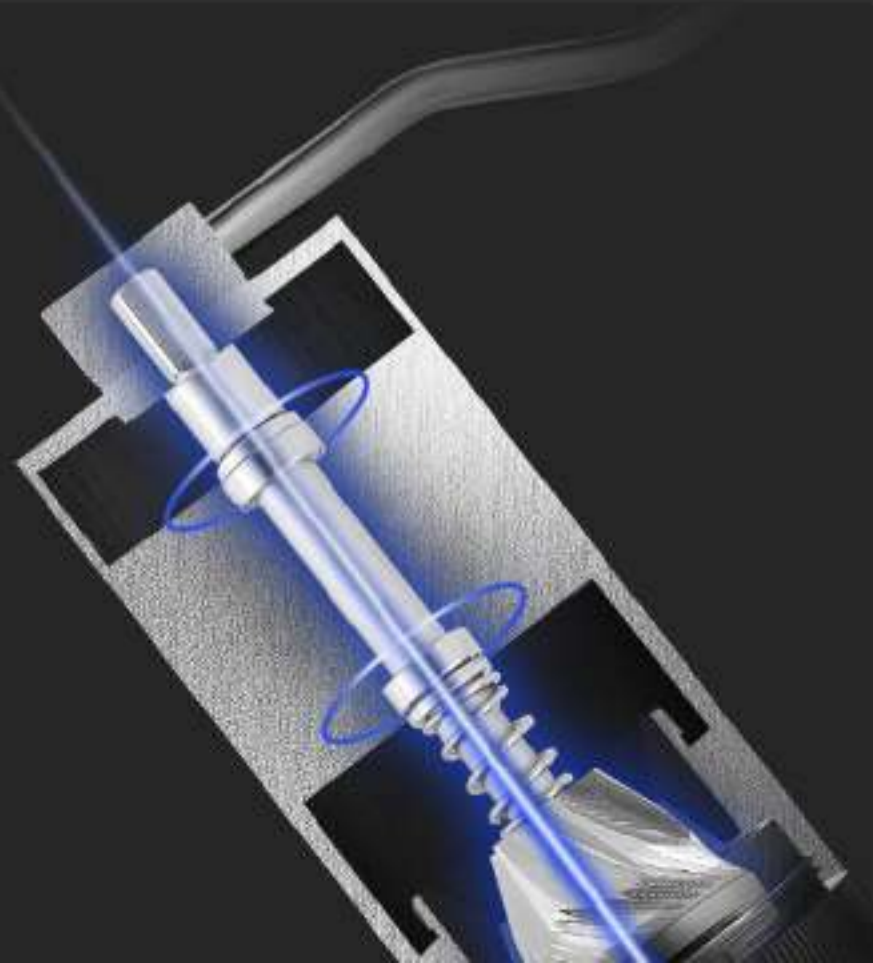



## 20g powder container

One time 1-2 cups



## Brand logo at the bottom

Details show the quality

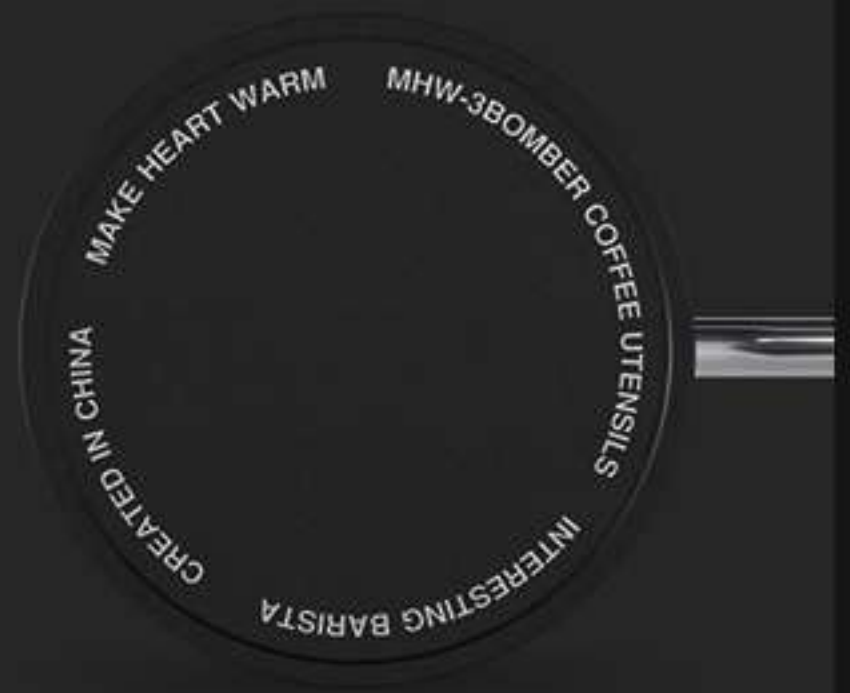

## Deerskin velvet storage bag

Easy to storage

# Easy to enjoy tasty coffee

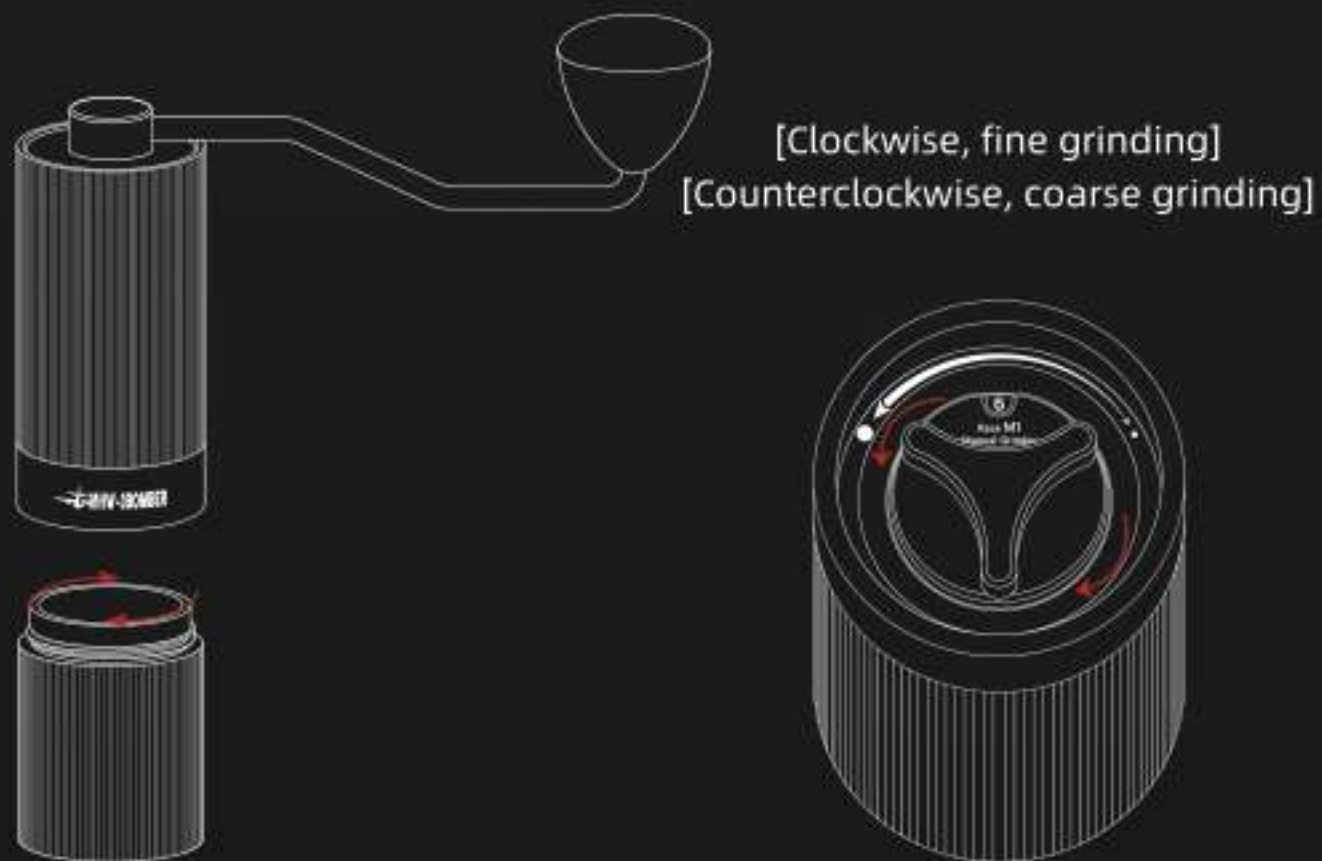

① Take Down The  
Powder Container

② Set The Coarseness

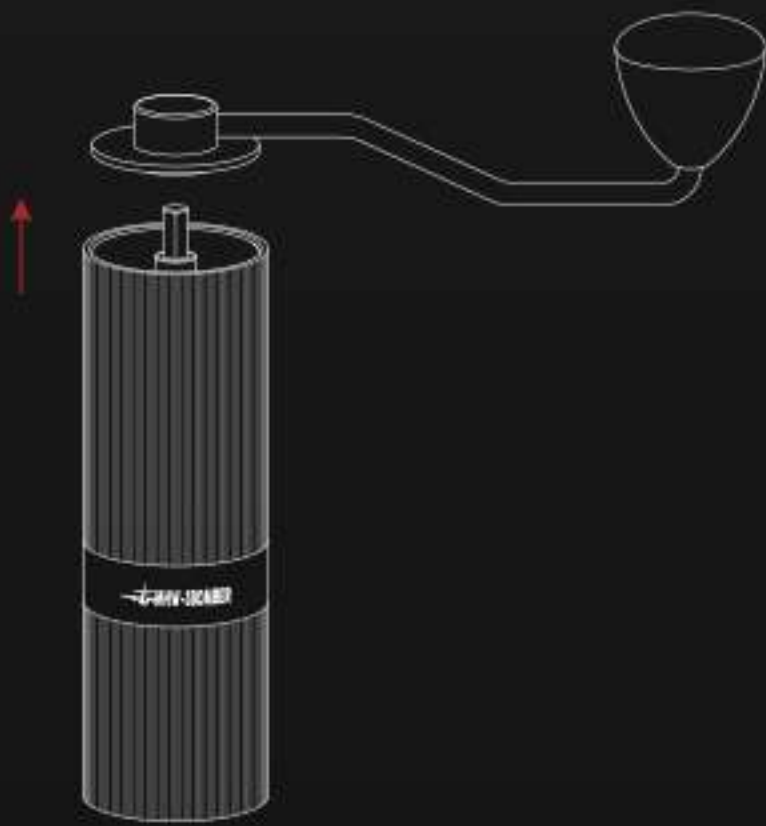

③ Open The Lid

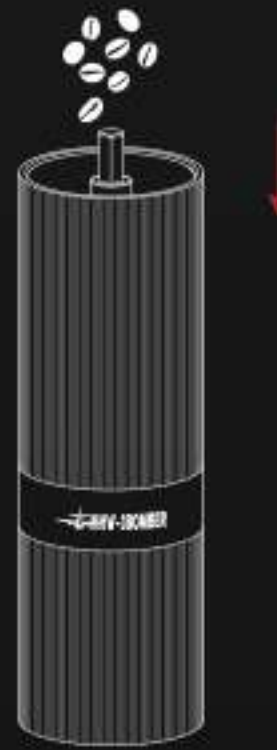

④ Pour Coffee Beans In



⑤ Start Grinding



⑥ Finish Grinding.  
Pour Out The Coffee Powder

# INFORMATION

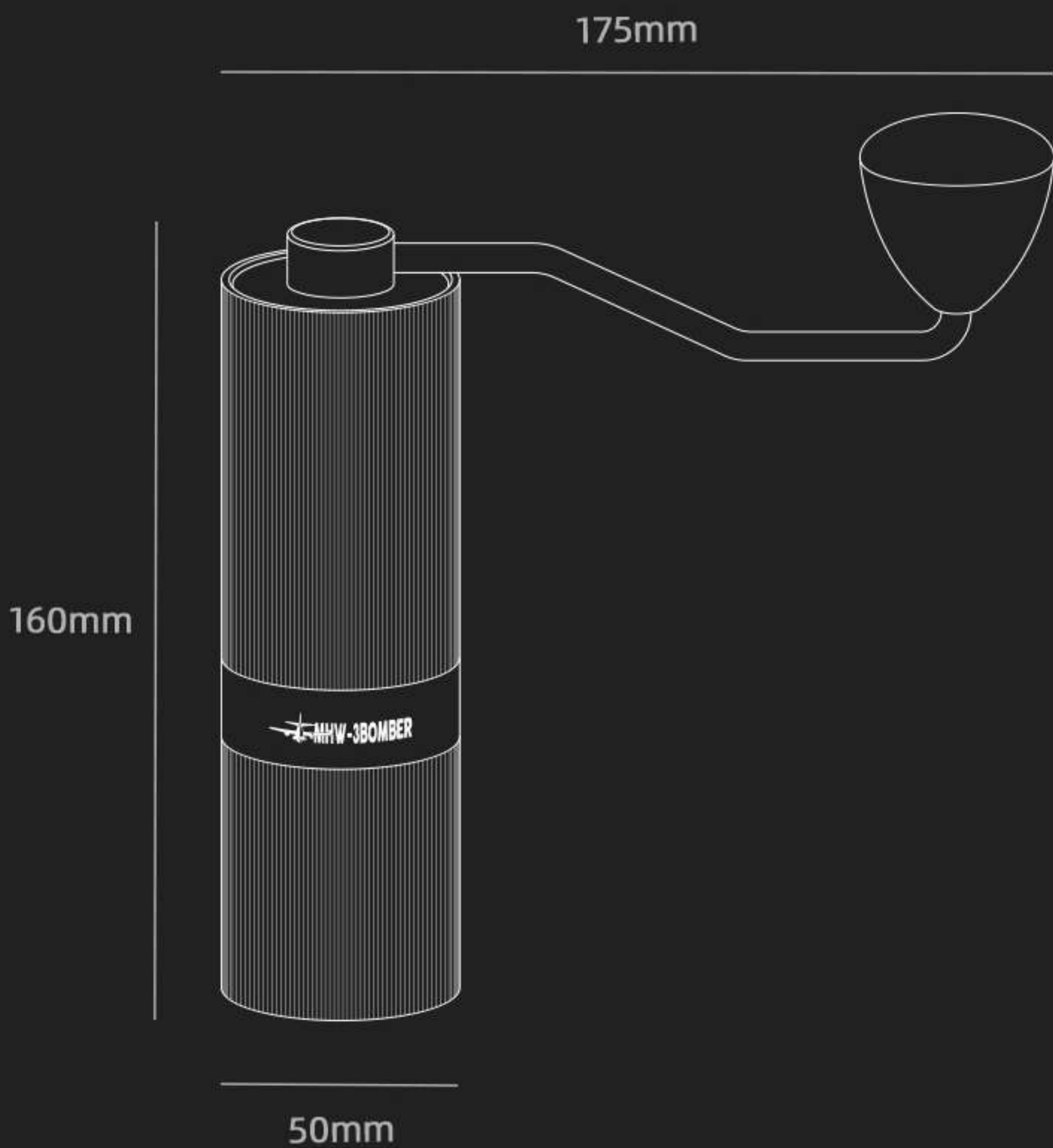
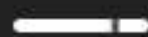

\* THERE MIGHT BE SOME ERROR IN  
MANUAL MEASUREMENT

<b>Brand</b> MHW-3BOMBER	<b>Name</b> Race M1 Manual Grinder
<b>Material</b> SUS304、SUS420、 ALUMINIUM ALLOY, WALNUT, MAPLE	<b>Capacity</b> 20g
<b>Weight</b> 500g	<b>Origin</b> China

# PACK



# WARM PROMPT



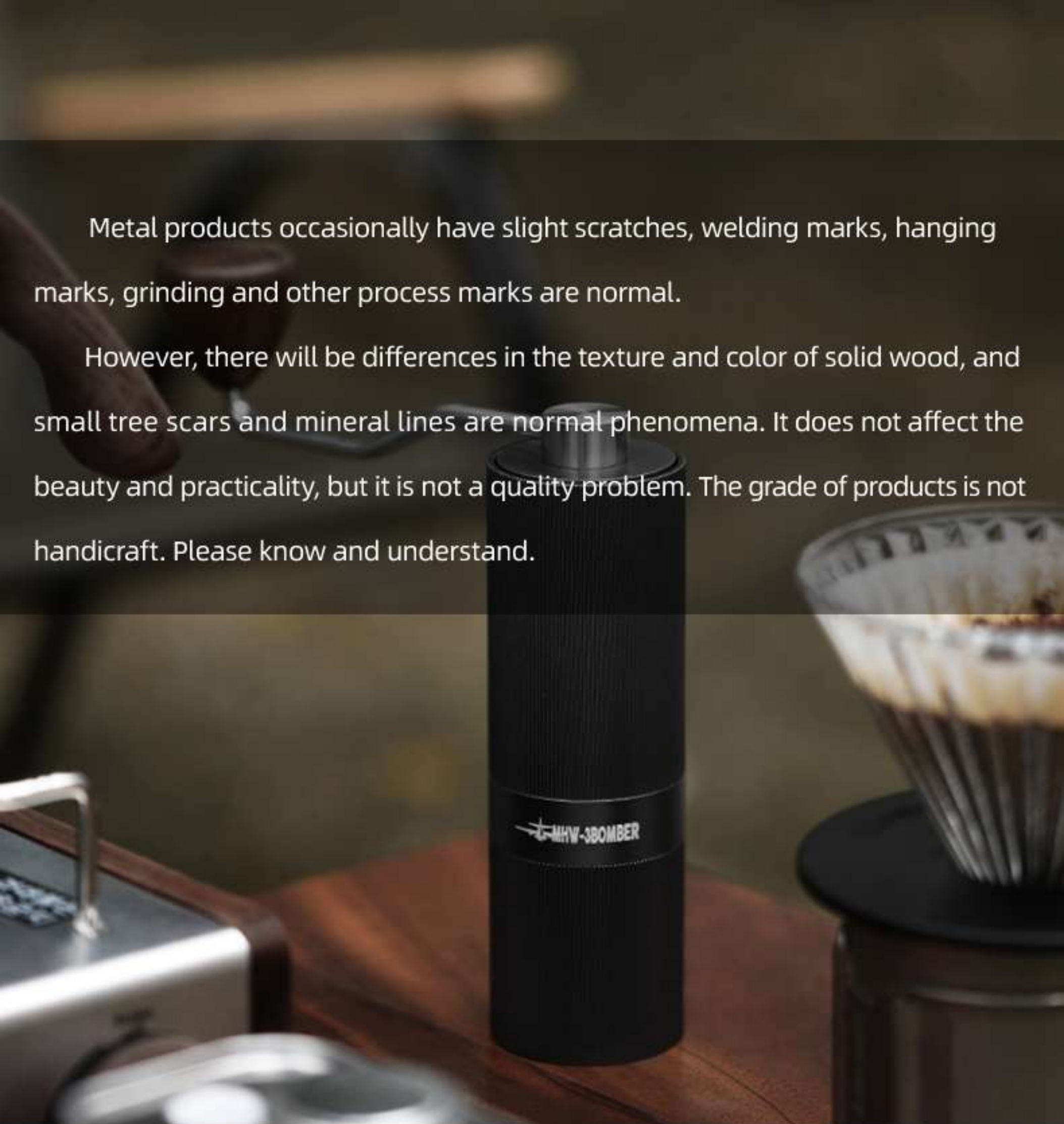

Metal products occasionally have slight scratches, welding marks, hanging marks, grinding and other process marks are normal.

However, there will be differences in the texture and color of solid wood, and small tree scars and mineral lines are normal phenomena. It does not affect the beauty and practicality, but it is not a quality problem. The grade of products is not handicraft. Please know and understand.

## NOTES

1. This product is only designed to grind coffee beans, Please do not grind other material;
2. Be careful of the sharp metal burrs, keep kids from using it;
3. Keep it in a cool and dry place.